

Quick Installation Guide

LiFePO4 Battery System for Households

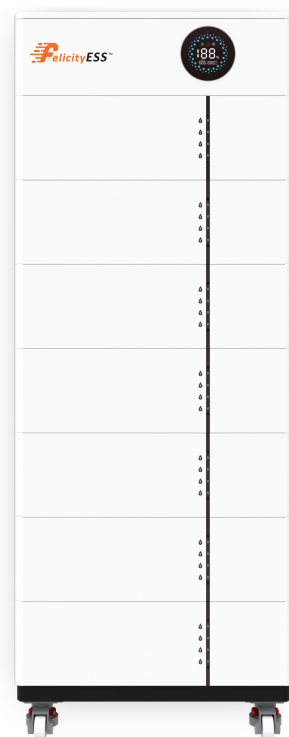

358-S030010-01

Disclaimer















- Please read the user's manual carefully before performing all operations; this installation guide does not supersede the use of the product's user's manual;
- Product information is subject to change without notice. This manual is frequently updated, please contact your salesperson for the latest version.
- After unpacking, please check the product for damages and missing parts.
- Do not open the battery to repair or disassemble. Only FelicityESS is allowed to carry out any such repairs. Only qualified personnel can install this device with battery.
- In case of fire, use only dry powder fire extinguisher. Liquid extinguishers should not be used.
- Before using the battery, please read the instructions and warning signs of the battery and corresponding sections in the instruction manual. Improper reassembly may result in electric shock or fire.
- To reduce risk of electric shock, disconnect all wires before attempting any maintenance or cleaning. Turning off the unit will not reduce this risk.
- Never charge a frozen battery.
- Be very cautious when working with metal tools on or around batteries. Dropping a tool may cause a spark or short circuit in batteries or other electrical parts, even cause an explosion.
- Install the battery away from children or pets.
- Do not use battery in high static environment where the protection device might be damaged.
- Battery should be installed indoor and kept away from water, high temperature mechanical force and flames.
- Do not install the battery in any environment of temperature below 0°C or over 55°C, and humidity over 80%.

Installation Video



You can watch the installation video by scanning the QR code to the right



Packing List

 base×1	 User manual×1	 Warranty card×1	 Power Cable×2
 Ground Wire×1	 Communication Cable 1×1	 Communication Cable 2×1	 Hole Marking Cardboard×1
 Hex Wrench×1	 OT Terminal×4	 Plastic Expansion Screw×4	 Screws M5X12*8 PCS Screws M6X16*16 PCS Screws M5X25*2 PCS
 Casters×4	 Signal Terminal×2	 Fixed trestle×4	



















LUX-X-48100LCG01/LUX-X-48100LCG01-US			
NO.	Name	Description	Quantity
1	Base	Used for product placement and plays a supporting role	1
2	User manual	User manual	1
3	Warranty card	Warranty card	1
4	Power Cable	0.9 meters, 35mm ² , allows for charging and discharging up to 150A, used for connecting to external PCS+ (red).	1
		2.3 meters, 35mm ² , allows for charging and discharging up to 150A, used for connecting to external PCS- (black).	1
5	Ground Wire	Used for grounding connections between the master and slave controllers.	1
6	Communication Cable 1	Used for CAN/RS485 communication with inverters from other brands.	1
7	Communication Cable 2	Used for RS485 communication with Felicity inverters	1
8	Hole Marking Cardboard	Used to mark drilling positions during product installation. For detailed installation instructions, please refer to the installation steps below.	1
9	Hex Wrench	Used as a tool for stacking and securing products. For detailed installation instructions, please refer to the installation steps below.	1
10	OT Terminal	Screw hole diameter 10.5mm, wire crimp hole diameter 17mm, used with 150mm ² power cables.	4
11	Plastic Expansion Screw	used together for product fixation.	4
12	Screws	Screws M5X12*8 PCS Screws M6X16*16 PCS Screws M5X25*2 PCS	/
13	Casters	Used for product support and short-distance transportation	4
14	Signal Terminal:	Used for creating custom communication cables.	2
15	Fixed trestle	Used for fixing products	4

 User manual×1	 Warranty card×1	 Ground Wire×1	 Plastic Expansion Screw×2
 Screws M5X12*4PCS Screws M5X25*2PCS	 Parallel Soft Copper Busbar×2	 Communication Cable ×1	 Fixed trestle×2

LUX-X-48100LMG01/LUX-X-48100LMG01-US			
NO.	Name	Description	Quantity
1	User manual	User manual	1
2	Warranty card	Warranty card	1

3	Ground Wire	Used for grounding connections between stackable battery packs.	1
4	Plastic expansion screws	Plastic expansion screws are used to secure products and walls	2
5	Screws	Screws M5X12*4PCS,Screws M5X25*2PCS	/
6	Parallel Soft Copper Busbar	allows for charging and discharging up to 450A, used for parallel connections between stackable battery packs.	2
7	Communication Cable	Used for communication connections between stackable battery packs.	1
8	Fixed trestle	Used for fixing products	2

Explanation of the Symbols

	Danger! Serious physical injury or even death may occur if not follow the relative requirements.		Install the product out of reach of children
	Caution, risk of electric shock.		Do not place or install near flammable or explosive materials
	In case of electrolyte leakage, keep leaked electrolyte away from eyes or skin.		Disconnect the equipment before carrying out maintenance or repair
	Do not connect the Pack's positive(+) and negative(-) terminal reversely.		Societe Generale de Surveillance S.A.
	Observe precautions for handling electrostatic discharge sensitive devices.		Instruction manual: Read the instruction manual before starting installation and operation.
	Caution, risk of electric shock, energy storage timed discharge		CE mark: The inverter complies with the CE directive.
	Recyclable.		NOTE Note: The procedures taken for ensuring proper operation.
	Do not use the Pack beyond specified conditions		Earth terminal: The inverter must be reliably grounded.
	Take care! This Pack is heavy enough to cause serious injury.		EU WEEE mark: Product should not be disposed as household waste.

Product Overview

Up to 8 PCS battery packs can be connected in parallel

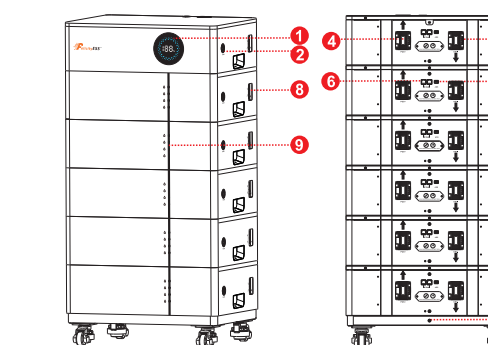

Code	Name
1	LCD display
2	Power On/Charging indicator
3	Battery Negative -
4	Battery Positive +
5	Switch
6	Communication port
7	Earth wire
8	Breaker
9	LED

Installation Environment

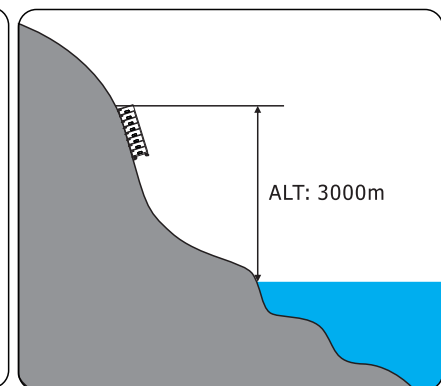
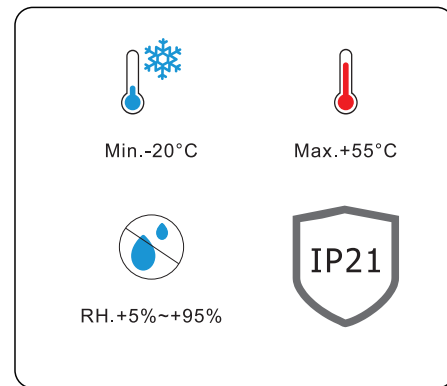
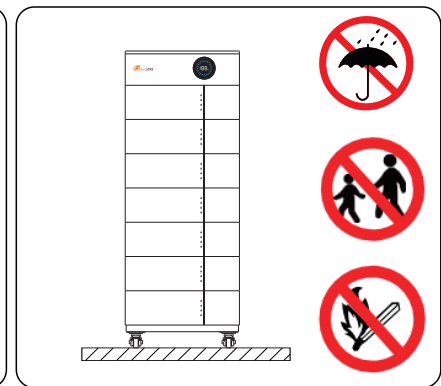
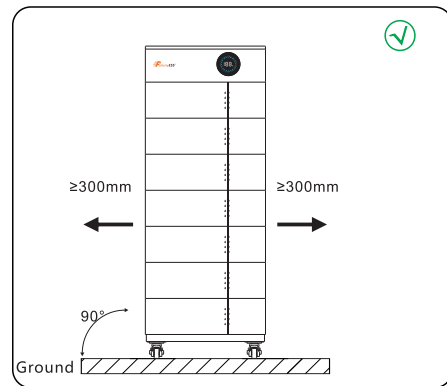
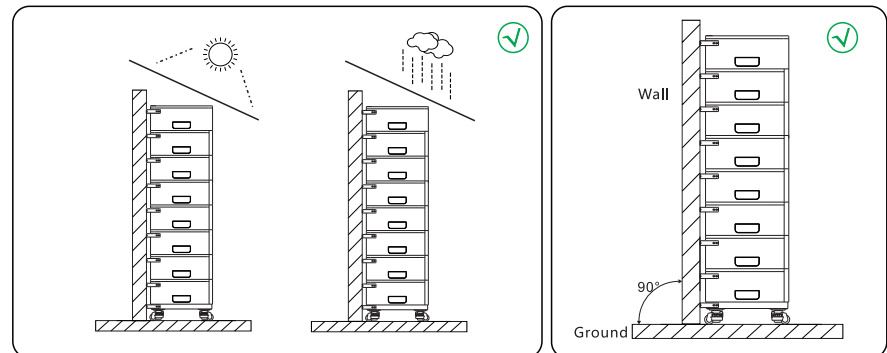

Description for LED

The LED shows the SOC of module N.

100%	75%	50%	25%	Flashing SOC < 10%

LCD Display Icons

Icon	Function Description
Display Information 	Indicates the voltage, current, temperature, SOC of the module. (Short press the button to display the information of each parallel module.)
	Indicates SOC
	Indicates battery level, each LED represents 5%. (When charging, this icon flashes; when discharging, the icon displays constant)
	Indicates settings.
	Indicates a fault.
	Indicates communication signs.

Installation Procedure

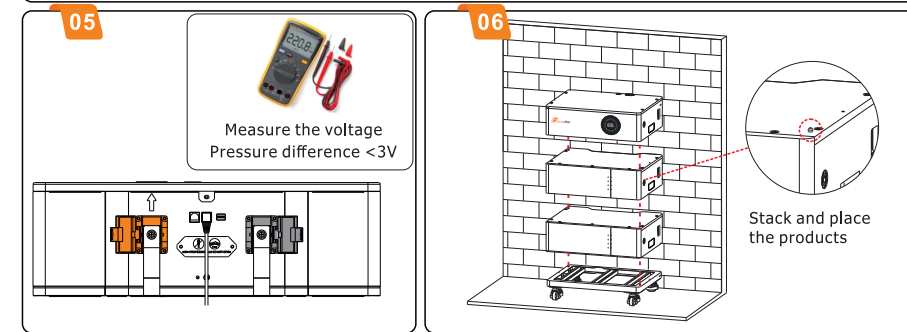
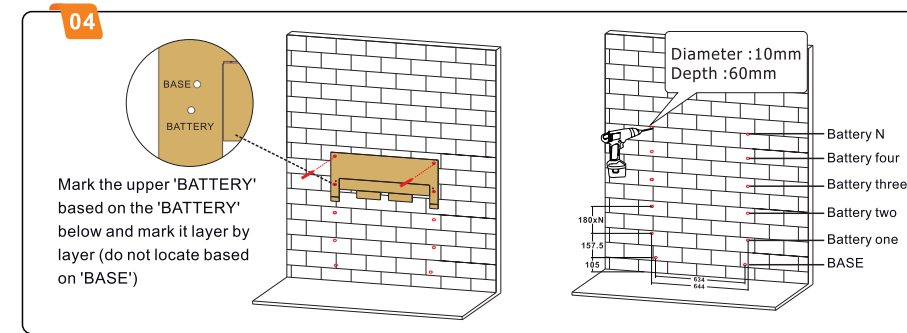
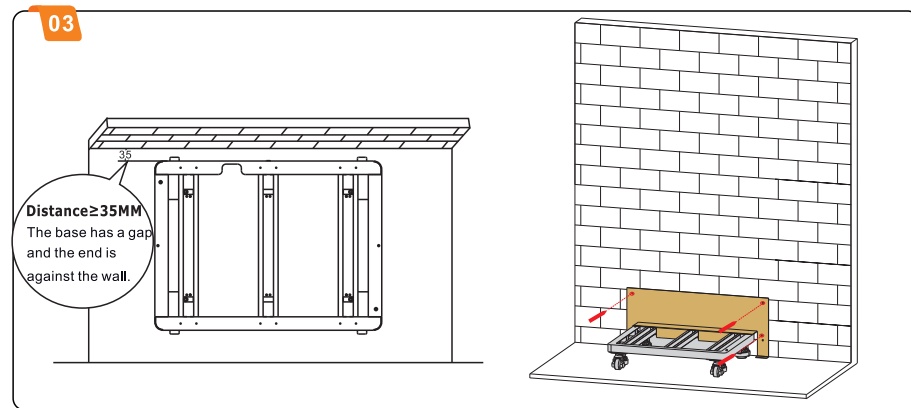
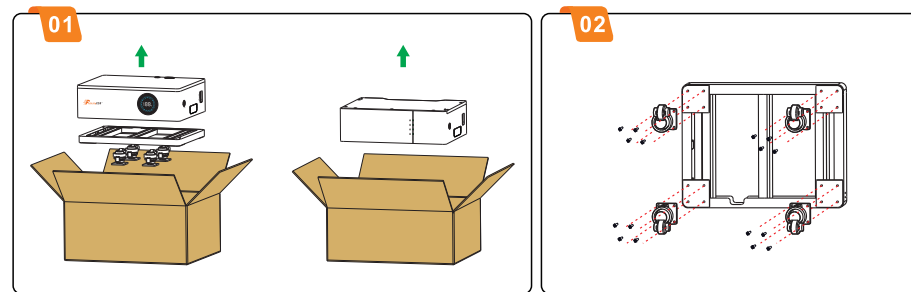

Connection for Parallel Mode

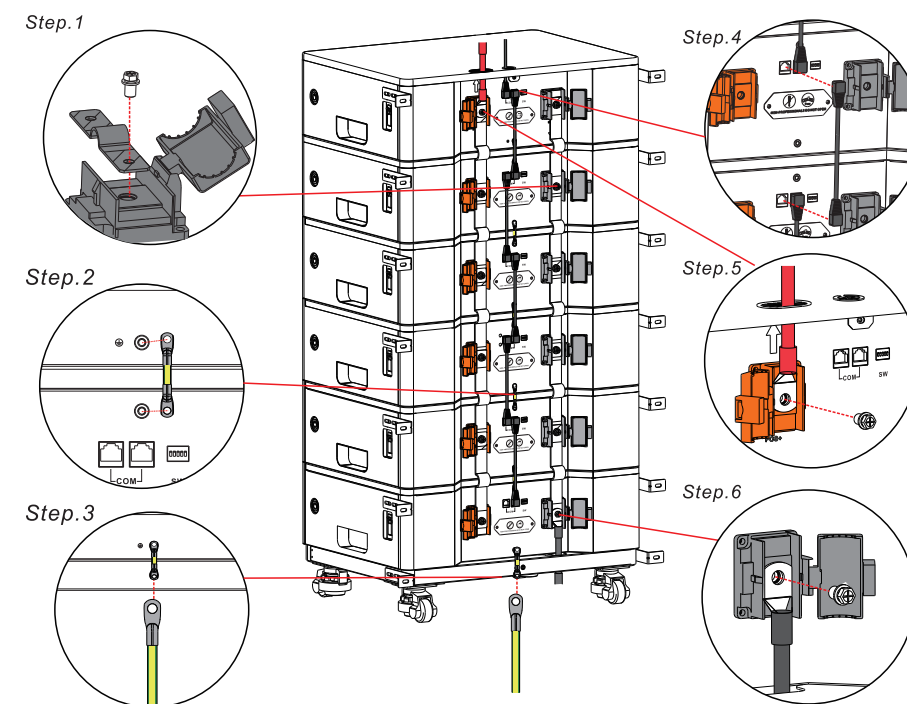

DIP Switch

No. of BAT	1	2	3	4	5	6	7	8
1PCS	1,5 ON							
2PCS	1,5 ON	2,5 ON						
3PCS	1,5 ON	2 ON	1,2,5 ON					
4PCS	1,5 ON	2 ON	1,2 ON	3,5 ON				
5PCS	1,5 ON	2 ON	1,2 ON	3 ON	1,3,5 ON			
6PCS	1,5 ON	2 ON	1,2 ON	3 ON	1,3 ON	2,3,5 ON		
7PCS	1,5 ON	2 ON	1,2 ON	3 ON	1,3 ON	2,3 ON	1,2,3,5 ON	
8PCS	1,5 ON	2 ON	1,2 ON	3 ON	1,3 ON	2,3 ON	1,2,3 ON	4,5 ON

Fixed Product

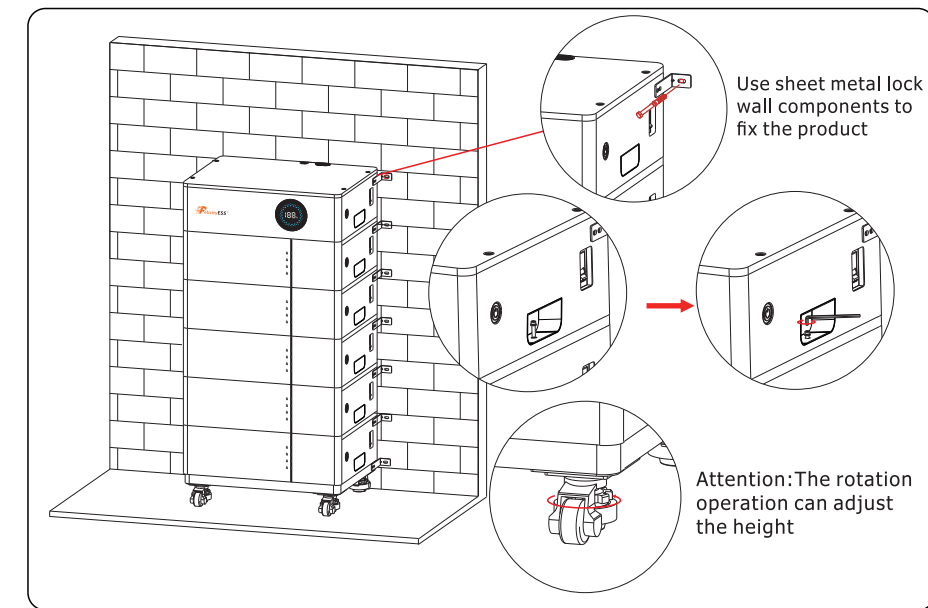

User Manual

User Manual in the QR code or at <https://www.felicityess.com/>

