

# USER MANUAL

LiFePO<sub>4</sub> Battery System for Households



LiFePO<sub>4</sub> Battery System

In order to prevent improper operation before use, please carefully read this manual.

# Contents

<b>1 ABOUT THIS MANUAL</b> .....	1
1.1 Purpose .....	1
1.2 Scope .....	1
1.3 Safety Instructions .....	1
1.4 Can be Connected in Parallel .....	1
<b>2 INTRODUCTION</b> .....	2
2.1 Features .....	2
2.2 Product Overview .....	2
2.3 Specifications .....	4
2.4 Recommended Settings .....	4
<b>3. Installation Procedure</b> .....	5
3.1 Setup Script .....	5
3.2 Tools .....	5
3.3 Floor Installation with Base.....	6
3.4 Installation Environment .....	6
3.5 Battery system switch operation.....	7
<b>4. INSTALLATION</b> .....	9
4.1 Unpacking and Inspection .....	9
4.2 Mounting the Unit .....	9
4.3 Connection for Parallel Mode .....	9
<b>5. OPERATION</b> .....	10
5.1 Switch On/Off.....	10
5.2 LCD Display Icons .....	11
5.3 BMS Information Page .....	11
5.4 Fault Code Table .....	12
5.5 DIP Switch SW1-SW4 Description .....	13
<b>6. Configure Network</b> .....	14
6.1 Download APP .....	14
6.2 Connect to Built-in WIFI wireless network .....	14
6.3 Configure the network .....	14
<b>7. Create the plant</b> .....	15
7.1 Manage device via APP .....	15
<b>8. EMERGENCY SITUATIONS</b> .....	17
8.1 Fire .....	17
8.2 Leaking Batteries .....	17
8.3 Wet Batteries .....	17
8.4 Damaged Batteries .....	17
8.5 Warranty .....	17

## 1 ABOUT THIS MANUAL

### 1.1 Purpose

This manual describes the introduction, installation, operation and emergency situations of the battery bank. Please read this manual carefully before installations and operations. Keep this manual for future reference.

### 1.2 Scope

This manual provides safety and installation guidelines as well as information on tools and wiring.

### 1.3 Safety Instructions



**WARNING:** This chapter contains important safety and operating instructions. Read and keep this manual for future reference.

1. Before using the unit, read all instructions and cautionary markings on the unit, the batteries and all appropriate sections of this manual.
2. CAUTION --- To reduce risk of injury, damage, even burst, please use it following using manual. In case of causing personal
3. Do not disassemble the battery. Take it to a qualified service center when service or repair is required. Incorrect re-assembly may result in a risk of fire.
4. To reduce risk of electric shock, disconnect all wirings before attempting any maintenance or cleaning. Turning off the unit will not reduce this risk.
5. CAUTION – Only qualified personnel can install this device with inverter.
6. For optimum operation of this battery, please follow required spec to select appropriate cable size.
7. Be very cautious when working with metal tools on or around batteries. A potential risk exists to drop a tool to spark or short circuit batteries or other electrical parts and could cause an explosion or fire.
8. Please strictly follow installation procedure.
9. To support full output load, at least 2 sets of FLA48V for inverter larger than 6KVA in parallel connection.
10. **GROUNDING INSTRUCTIONS** - This System should be connected to a permanent grounded wiring system. Be sure to comply with local requirements.
11. NEVER cause AC output and DC input short circuited. Do not connect to the mains when DC input short circuits.
12. Warning!! Only qualified service persons are able to service this device.
13. Battery should be installed indoor and kept away from water, high temperature mechanical force and flames.
14. Do not install the battery in any environment of temperature below 0°C or over 55°C, and humidity over 80%.
15. Do not put any heavy objects on the battery.

### 1.4 Can be connected in parallel

**1. The batteries can be connected in parallel. Series connection is not allowed.**

**Use in upright position only.**

**2. The batteries are not allowed to connected with PWM controller for charging.**

**3. The batteries are allowed to connected with MPPT controller for charging, but the maximum PV voltage in the system must be less than 100Vdc.**

**Special Attention: Due to the built-in protection board of the lithium battery pack is with over-discharge protection function, it is strongly recommended to stop using the load when the battery pack is over-discharged. The battery pack cannot be repeatedly activated for discharge. Or the battery may be failed to be activated by the AC or PV activation cable (It requires a special charging activation method), so cannot be charged. Therefore, when the battery pack is low power, please charge the battery as soon as possible when main power or solar energy is available.**

## 2. INTRODUCTION

The battery system main using solar power system for family house. It also have a with to controller the battery easily and protect our Household application timely.

### 2.1 Features

LiFePO4: Higher safe performance and longer cycle life.

Multiple Protection: Built-in smart BMS, Breaker and Fuse.

Flexible Installation: Wall-Mounted or Floor-Mounted.

Wide Compatibility: Compatible with leading inverter brands.

High Scalability: Capacity up to 150kWh.

Long Warranty: 7 Years.

Built-in WIFI: Remote monitor of the battery pack data.

### 2.2 Product Overview

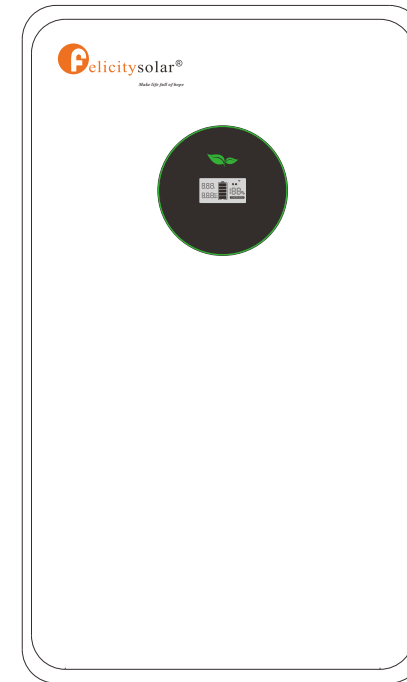

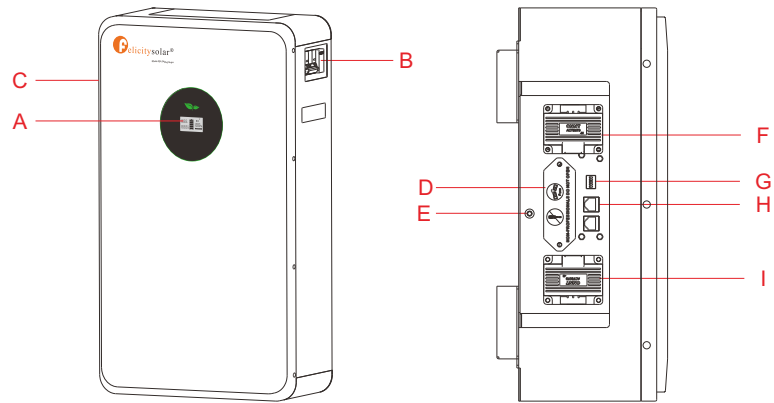

Code	Name
A	LCD display
B	Breaker
C	Power On/Charging indicator
D	Fuse
E	Earth wire
F	Battery Positive +
G	Switch
H	Communication port
I	Battery Negative -

### 2.3 Specifications

Model	FLA48200
Energy	10kWh
Battery Type	LiFePO4
Nominal Voltage	51.2V
Operating Voltage	44.8-57.6V
Recommend Charge/Discharge Current[1]	≤120A
Recommend Charge/Discharge Power[1]	≤6,000W
Maximum Charge/Discharge Current(15s)	150A
Maximum Charge/Discharge Power(15s)	7,500W
Depth of Discharge(DOD)	≥ 95%
Scalability	Up to 15 units in parallel(150kWh)
Communication	RS485 / CAN
Protection Level	IP21
Cycle Life[2]	≥ 6,000 Cycles
Charging Temperature Range	0-55 °C
Discharging Temperature Range	-20-55 °C
Display	LCD+LED
Installation	Wall-Mounted / Floor-Mounted
Protection	Built-in smart BMS, Breaker, Fuse
Warranty	7 Years
Net Weight	68kg
Gross Weight	88kg
Product Dimension	735×433×188mm
Package Dimension	849×550×362mm
[1] Recommend charge/discharge current/power is affected by temperature and SOC.	
[2] Test conditions: 0.2C Charging/Discharging @25°C, 80% DOD.	

### 2.4 Recommended Settings

Lithium battery pack is not same as lead-acid battery, so for the devices which you connect with the battery pack for charging or discharging, such as inverters, MPPT charger controllers or UPS, please implement pre-settings as recommended settings as below before you launched them.

Setting	FLA48200
Max. Charging Voltage	57.6V
Floating Charging Voltage	57.6V
Max. Charging Current	120A*N
Cut-off Voltage	48V

Notes: "N" means the number of battery packs connected in parallel.

### 3. Installation Procedure

#### 3.1 Setup Script

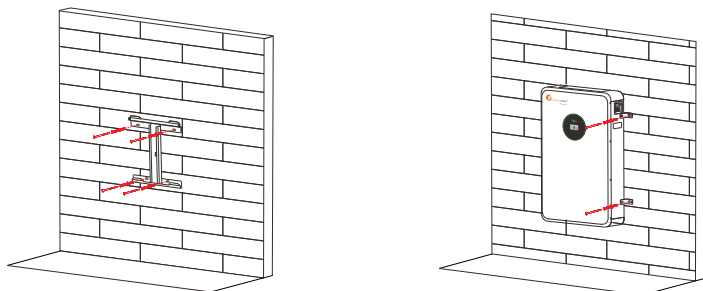

Using wall mounted components, first fix the wall mounted components to the wall, and then lift the machine onto the wall mounted components to secure it

Note: Do not use wall mounted components, place the chassis against the wall and secure it with fixing components

#### 3.2 Tools



Screw Driver



Crimping Modular



Safety Shoes



Multimeter



Safety Gloves



Safety Goggles



Plier



Ribbon



Electric drill

#### 3.3 Floor Installation with Base

##### Installation Location Requirements

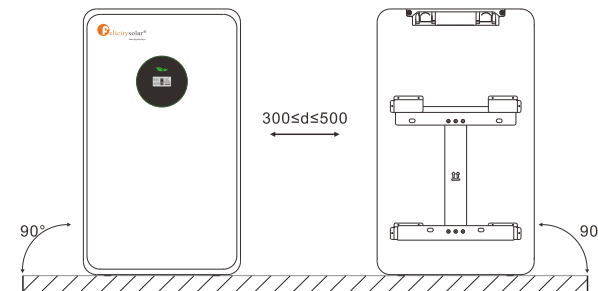

Ground (Two rows installation)

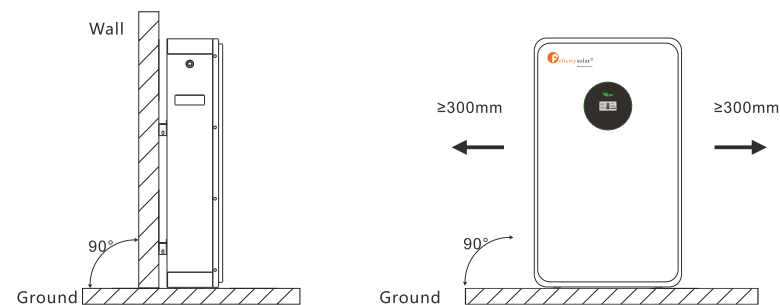

#### 3.4 Installation Environment

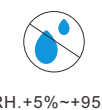
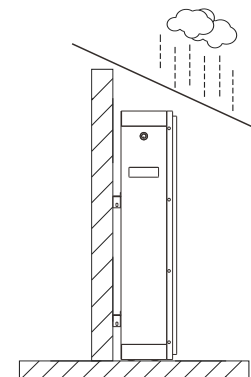
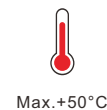
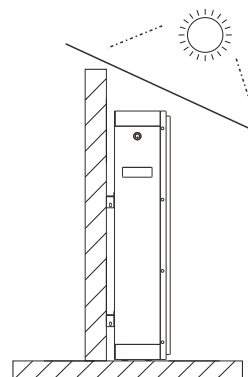

### 3.5 Battery system switch operation

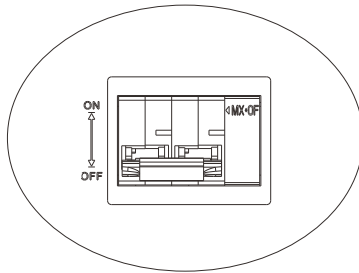

#### Power on battery system:

Turn the breaker to the "ON" state, press the POWER button 1 seconds, wait for the battery system LED light to light up, indicating that the boot is complete.

#### Power off battery system:

Turn the breaker to the "OFF" state, turn off the entire battery system.

## 4. INSTALLATION

### 4.1 Unpacking and Inspection

Before installation, please inspect the unit. Be sure that nothing inside the package is damaged. You should have received the following items inside of package.

NO	NAME	SPECIFICATION	PICTURE
1	RS485 cable	Battery terminal: 5B6A PCS terminal: 5B6A	
2	Lock wall components	Used for product transportation and wall fixation	
3	Cables	Used for battery parallel connection Wire diameter 35mm <sup>2</sup>	
4	User manual	User manual	
5	Guarantee card	Guarantee card	
6	Screw	Mounting screw	
7	Universal communication cable	Flexibly match the communication cable of different inverters	
8	Communication line	Used for communication among batteries	
9	Ethernet connector	Ethernet connector	

### 4.2 Mounting the Unit

Consider the following points before selecting where to install:

- Do not mount the battery on flammable construction materials.
- The ambient temperature should be between 0°C and 45°C to ensure optimal operation.
- The recommended installation position is to be adhered to the wall vertically.
- Be sure to keep other objects and surfaces as shown in the right diagram to guarantee sufficient heat dissipation and to have enough space for removing wires.

Please follow below steps to implement battery connection:

1. Assemble battery ring terminal based on recommended battery cable and terminal size.
2. Connect all battery packs as units requires. It's suggested to connect at least 2 sets for inverter larger than 8KVA in parallel connection.

**Note: if you need the battery wake-up when the grid is back, connect the battery with grid use power adapter and communication line 1 shown in the package list.**

### 4.3 Connection for Parallel Mode

The FLA series battery support to be connected in parallel for expansion. If you need one more battery bank to work in parallel mode, connect the battery as shown in PIC 1.

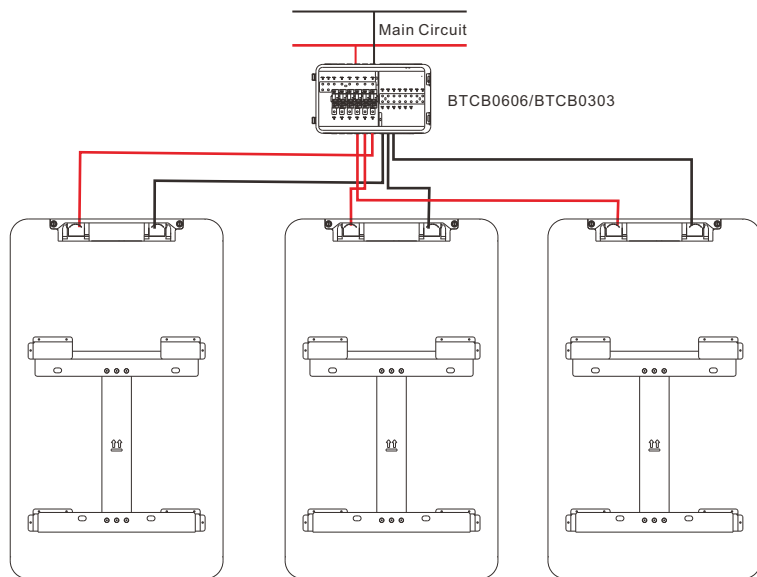

**Step :** The schematic diagram of the parallel connection of three battery packs is shown in Figure 1.

**Note:**After completing the above steps, arbitrarily select the positive and negative poles of one of the battery packs to output. After confirming the correct connection of the inverter, controller and battery, you can turn on any of the switches and use the battery group happily.

For pure off grid system ,the PV awake wire need to be connected with MPPT charge controller if the battery pack is charged by solar panels only . The connection diagram as below :

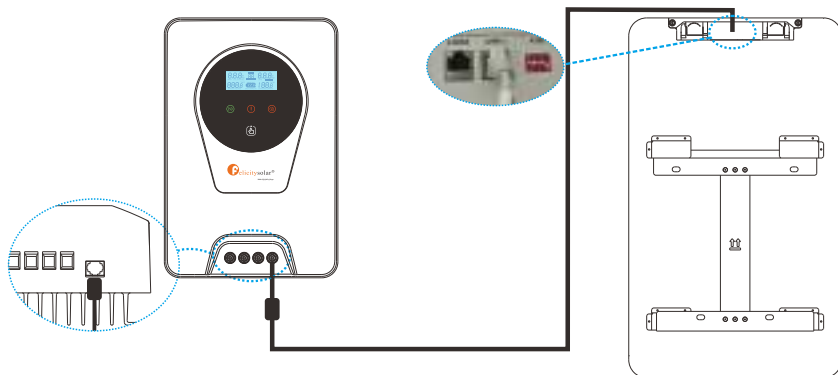

## 5. OPERATION

Once the batteries are connected well, close the breaker to the ON block, press On/Off button to enable the output of the battery pack.

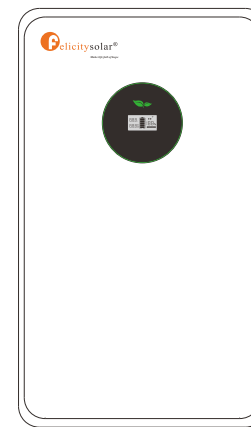





### 5.1 Switch On / Off

- 1.Switch on: press On/Off button to switch on the battery, then the battery will do self-inspection before enable output. The LCD will show the SOC.
- 2.Switch off: press and hold On/Off button for 1to3 seconds, the battery will shut down directly.

Picture	PIN	Description
	1	Trigger-GND
	2	Trigger-VCC
	3	CANL-PCS
	4	CANH-PCS
	5	RS485-B
	6	RS485-A
	7	CANL
	8	CANH

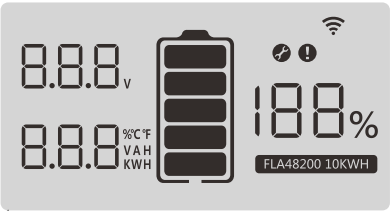
DIP SWITCH		
	1-4	Communication Address
	5	Termination Resister

### 5.2 LCD Display Icons

	
Icon	Function Description
Display Information	
8.8.8 <sub>v</sub>	Indicates battery voltage.
8.8.8 <sub>A</sub> KW	Indicates battery current or watt Short press the switch button to switch watt and current
188%	Indicate SOC.
Battery Information	
	Indicates battery level by 0-20%,21-40%, 41-60%61-80%,81-100%.(When charging,this icon is displayed for horse running;When discharging,the icon displays constant).
Fault information	
	Indicates a fault.
set information	
	Indicates settings.

### 5.3 BMS Information Page

The basic information will be displayed in turn after power on.

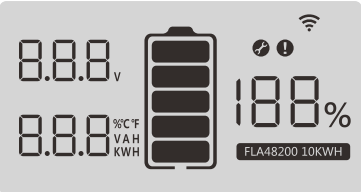
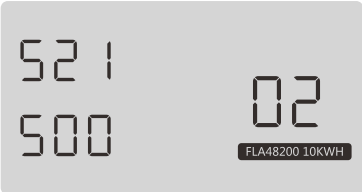
<p><b>BMS power on information</b> BMS information is all on.</p> 	<p><b>BMS version</b> Eg: "521" is the software version ;"500" is the IAP version and temporary version;"02" is the countdown.</p> 
--	--

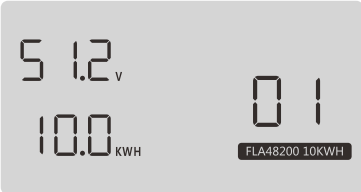
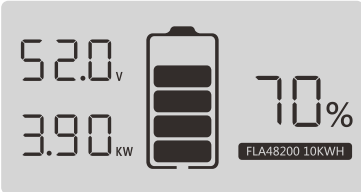
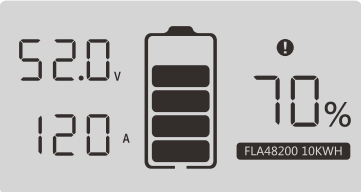
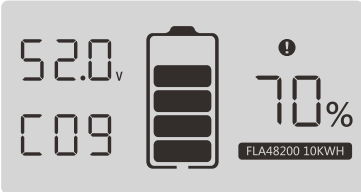
<p><b>BMS type</b> Eg: Rated voltage is "51.2V"; model is "10KWH". "01" is the countdown.</p> 	<p><b>BMS data</b> Eg: "52.0V" / "3.90KW" / "70%" refers to battery voltage, power and SOC.</p> 
<p><b>BMS data</b> Eg: "52.0V" / "120A" / "70%" refers to battery voltage, current and SOC.</p> 	<p><b>BMS fault code / flag</b> Eg: "52.0V" / "C09" / "70%" are battery voltage, fault code and SOC respectively, and Fault icon constant.</p> 

### 5.4 Fault Code Table

Fault Code	Fault Information	Trouble Shooting
C01	Battery overvoltage	Restart the unit, If the error happens again, please return to repair center.
C02	Battery undervoltage	Restart the unit, If the error happens again, please return to repair center.
C03	Cell overvoltage	Restart the unit, If the error happens again, please return to repair center.
C04	Cell undervoltage	Restart the unit, If the error happens again, please return to repair center.
C05	Charge overcurrent	Restart the unit, If the error happens again, please return to repair center.
C06	Discharge overcurrent	Restart the unit, If the error happens again, please return to repair center.
C07	MOS overtemperature	1 .The inner temperature is over the limitation. 2. Check whether the ambient temperature is too high.
C08	MOS undertemperature	1. The internal temperature is lower than the limit range. 2. Check whether the ambient temperature is too low.



C09	Cell overtemperature	Restart the unit, If the error happens again, please return to repair center.
C10	Cell undertemperature	Restart the unit, If the error happens again, please return to repair center.
C11	Abnormal current sampling	Restart the unit, If the error happens again, please return to repair center.
C12	Abnormal output impedance	Restart the unit, If the error happens again, please return to repair center.
C13	Parallel failed	1. Please check if single unit is installed to parallel system. 2. If this error happens during parallel installation, please check wires connection. If they are connected correctly, please finish parallel installation first, and then restart the unit. 3. If the problem remains, please contact your installer.
C14	Output loss	1. Please check whether the circuit breaker is closed; 2. Please check whether the fuse is normal; 3. Restart the unit, If the error happens again, please return to repair center.

### 5.5 DIP Switch SW1-SW4 Description

DIP switch SW1-SW4 Description ①					DIP switch SW5 Description②	
Sw1	SW2	SW3	SW4	Remarks	SW5	Remarks
0	0	0	0	means ID=0, communication address is 0x00/0x10③	1	means connect 120Ω resistor
1	0	0	0	means ID=1, communication address is 0x01④		
0	1	0	0	means ID=2, communication address is 0x02	0	means disconnect 120Ω resistor
1	1	0	0	means ID=3, communication address is 0x03		
0	0	1	0	means ID=4, communication address is 0x04		
1	0	1	0	means ID=5, communication address is 0x05		
0	1	1	0	means ID=6, communication address is 0x06		
1	1	1	0	means ID=7, communication address is 0x07		
0	0	0	1	means ID=8, communication address is 0x08		
1	0	0	1	means ID=9, communication address is 0x09		
0	1	0	1	means ID=10, communication address is 0x0A		
1	1	0	1	means ID=11, communication address is 0x0B		
0	0	1	1	means ID=12, communication address is 0x0C		
1	0	1	1	means ID=13, communication address is 0x0D		
0	1	1	1	means ID=14, communication address is 0x0E		
1	1	1	1	means ID=15, communication address is 0x0F		

Remark①: 1 in SW1-SW5 indicates ON status, and 0 indicates OFF status.

Remark②: When multiple battery packs communicate, the last battery pack SW5 needs to be in the ON status, otherwise the communication may have interference.

Remark③: When the battery pack ID is set to 0, it means stand-alone operation, and it is not necessary to detect whether the parallel condition is satisfied ⑤

Remark④: When the battery pack ID is set to 1-15, it means that the parallel operation is required, and it is necessary to detect whether the parallel condition is satisfied ⑤

Remark⑤: The parallel condition is that the difference between the battery voltage of the local battery and all the battery pack voltages is <3V, otherwise wait until the condition is satisfied

## 6. Configure Network

### 6.1 Download APP

Scan the QR Code on the right side and download the APP.



Fsolara APP

### 6.2 Connect to Built-in WIFI wireless network

Configure the mobile phone WLAN to connect to the wireless network of the Built-in WIFI

- 1) Run the APP, enter the login page, click the [Setup network] button to enter the network configuration page.
- 2) On the network configuration page, click the [Switch] button to enter the mobile phone WLAN page.

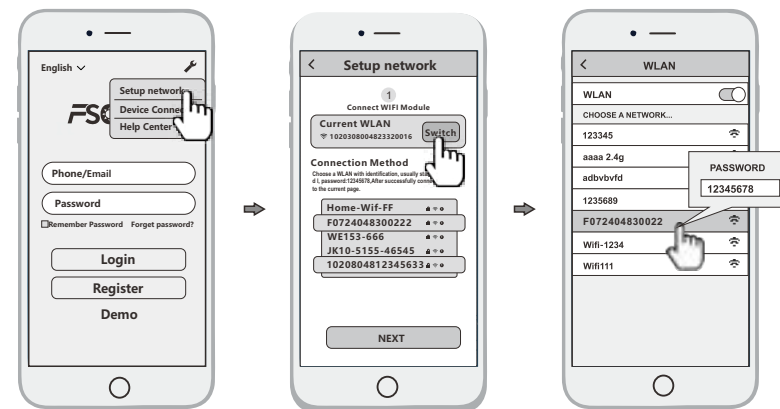

Configure the mobile phone WLAN to connect to the wireless network of the Built-in WIFI.

- 1) Run the APP, enter the login page, click the [Setup network] button to enter the network configuration page.
- 2) On the network configuration page, click the [Switch] button to enter the mobile phone WLAN page.
- 3) On the WLAN page of the mobile phone, find the corresponding wireless network name (SSID) of the Smart WiFi module, starting with F (e.g. Fxxxxxxxxxxxxxxxx, the xxxxxxxxxxxxxxxxxxx is the same as the device serial number). enter the module wireless network password (default password: 12345678), and connect to the wireless network of the Built-in WIFI.

### 6.3 Configure the network

- 1) After the mobile WLAN is connected to the wireless network of the Built-in WIFI, return to the network configuration page of the APP and click the [NEXT] button to enter the WiFi network page.
- 2) On the WiFi network page, select the router wireless network to which the Built-in WIFI needs to connect, or directly enter the route name, enter the router wireless network password and click the [NEXT] button.

3) And then wait for the Built-in WIFI to connect to the router's wireless network, which will take some time. Then you can use the diagnostic function of the APP or according to the fault appendix to troubleshoot the problem.

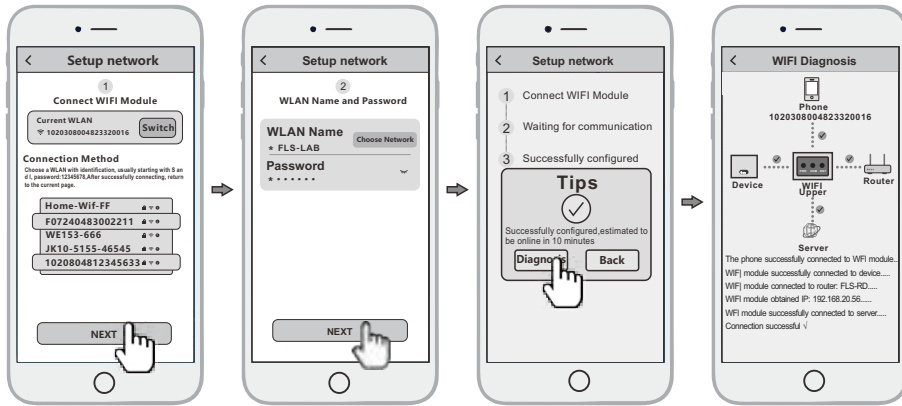

## 7. Create the plant

After the Built-in WIFI is connected to the server, it will transmit the data of the device to the server. And after the plant is created, users can view and manage the device via the APP or web browser.

### 7.1 Manage device via APP

#### 7.1.1 Register an account

Run the app, enter the login page, click the [Registration] button, select the role you want to register, and fill in the relevant information (optional email/phone number) to register.

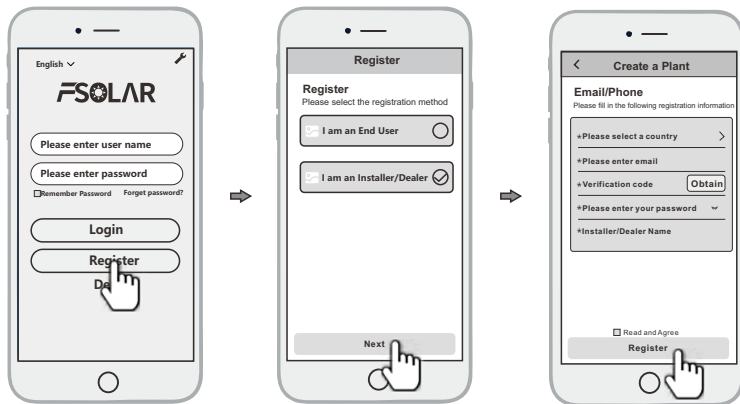

#### 7.1.2 New power station construction

1) Log in with the newly registered account, enter the homepage, and click on [ Create A Plant ]

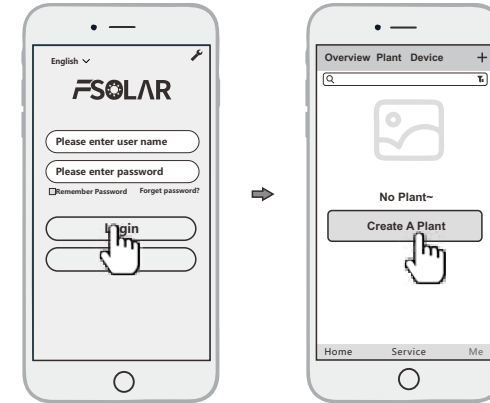

2) Adding the device, fill in the corresponding information and click [OK] to complete it.

3) Click on [ Add Device ], click on the icon above [Scan], align it with the barcode/QR code on the edge of the inverter or battery pack, and scan it.

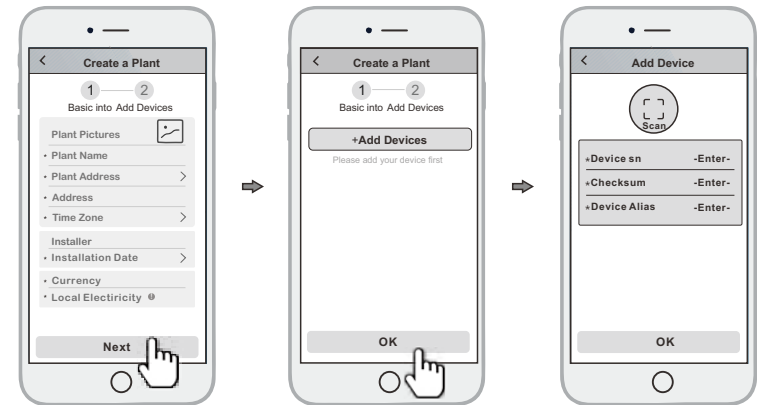

4) Manage the device via a web browser, please refer to: <https://shine.felicitysolar.com>.

## 8. EMERGENCY SITUATIONS

Felicity cannot guarantee battery absolute safety.

### 8.1 Fire

In case of fires, make sure that the following equipment is available near the system.

- SCBA (self-contained breathing apparatus) and protective gear in compliance with the Directive on Personal Protective Equipment 89/686/EEC.
- NOVEC 1230, FM-200, or dioxide extinguisher

Batteries may explode when heated above 150°C. KEEP FAR AWAY from the battery if it catches fire.

### 8.2 Leaking Batteries

If the battery pack leaks electrolyte, avoid contact with the leaking liquid or gas. If one is exposed the leaked substance, immediately perform the actions described below.

- Inhalation: Evacuate the contaminated area, and seek medical attention.
- Contact with eyes: Rinse eyes with running water for 5 minutes, and seek medical attention.
- Contact with skin: Wash the affected area thoroughly with soap and water, and seek medical attention.
- Ingestion: Induce vomiting, and seek medical attention.

### 8.3 Wet Batteries

If the battery pack is wet or submerged in water, do not let people access it, and contact your supplier for help.

### 8.4 Damaged Batteries

Damaged batteries are not fit for use and are dangerous and must be handled with the utmost care. It may leak electrolyte or produce flammable gas. If the battery pack seems to be damaged, pack it in its original container, and then return it to your supplier.

### 8.5 Warranty

Products that are operated strictly in accordance with the user manual are covered by the warranty. Any violation of this manual may void the warranty.

#### Limitation of Liability

Any product damage or property loss caused by the following conditions, Felicity does not assume any direct or indirect liability.

- Product modified, design changed or parts replaced.
- Changed, or attempted repairs and erasing of series number or seals;
- System design and installation are not in compliance with standards and regulations;
- The product has been improperly stored in end user's premises;
- Transport damage (including painting scratch caused by movement inside packaging during shipping). A claim should be made directly to shipping or insurance company.