

Quick Installation Guide

LiFePO4 Battery System for Households

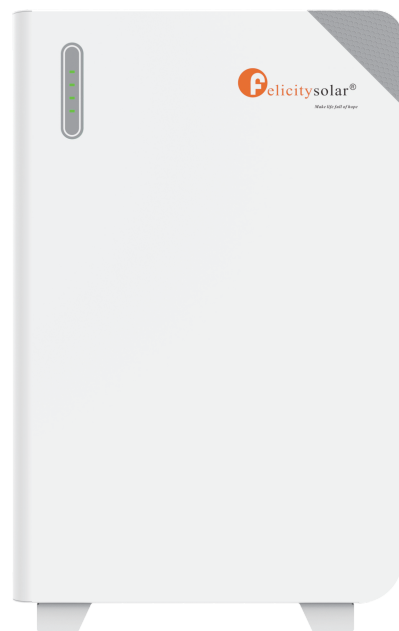







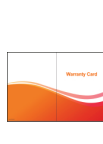

358-030048-00

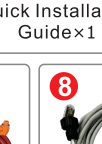
Disclaimer

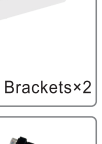
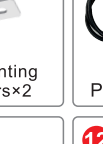













- Please read the user's manual carefully before performing all operations; this installation guide does not supersede the use of the product's user's manual;
- Product information is subject to change without notice. This manual is frequently updated, please contact your salesperson for the latest version.
- After unpacking, please check the product for damages and missing parts.
- Do not open the battery to repair or disassemble. Only FelicitySolar is allowed to carry out any such repairs. Only qualified personnel can install this device with battery.
- In case of fire, use only dry powder fire extinguisher. Liquid extinguishers should not be used.
- Before using the battery, please read the instructions and warning signs of the battery and corresponding sections in the instruction manual. Improper reassembly may result in electric shock or fire.
- To reduce risk of electric shock, disconnect all wires before attempting any maintenance or cleaning. Turning off the unit will not reduce this risk.
- Never charge a frozen battery.
- Be very cautious when working with metal tools on or around batteries. Dropping a tool may cause a spark or short circuit in batteries or other electrical parts, even cause an explosion.
- Install the battery away from children or pets.
- Do not use battery in high static environment where the protection device might be damaged.
- Battery should be installed indoor and kept away from water, high temperature mechanical force and flames.
- Do not install the battery in any environment of temperature below -20°C or over 55°C, and humidity over 95%.

Packing List

1  User Manual×1	2  Warranty Card ×1	3  Quick Installation Guide×1	4 (Optional)  Lock Wall Components×1
5  Stacking Brackets×2	6  Wall Mounting Fasteners×2	7  Power Cable×2	8  Communication Cable×1
9  Communication Cable×1	10  Communication Cable×1	11  Screws M8X60*2 PCS Screws M6X14*4 PCS	12  Signal Terminal×2
13  Ribbon×3	14  Fuse×1		

NO.	Name	Description	Quantity
1	User Manual	User manual	1
2	Warranty Card	Warranty card	1
3	Quick Installation Guide	Quick Installation Guide	1
4	Wall-mounting Kit (Optional)	For wall-mount installation of the product (Optional; purchased separately) Wall bracket * 1 PCS + M8×60 expansion Screws * 4 PCS+ M4×12 Screws * 2 PCS	1
5	Stacking Brackets	Used for front and rear stacking and fixation of batteries	2
6	Wall Mounting Fasteners	Used to secure the product to the wall	2
7	Power Cable	Used for connecting to external PCS	2
8	Communication Cable	Gray, used for RS485 communication with Felicity inverters (Model:IVCM,IVEM,IVPS/M IVGM)	1
9	Communication Cable	Blue, Used for communication with inverters from other brands.	1
10	Communication Cable	Black, used for parallel communication between battery packs	1
11	Screw	Screws M8X60*2 PCS Screws M6X14*4 PCS	/
12	Signal Terminal	Used for creating custom communication cables	2
13	Ribbon	Used to fix the power cable	3
14	Fuse	Spare parts for repair and replacement in case of fuse damage	1

Explanation of the Symbols

	Danger! Serious physical injury or even death may occur if not follow the relative requirements.		Install the product out of reach of children
	Caution, risk of electric shock.		Do not place or install near flammable or explosive materials
	In case of electrolyte leakage, keep leaked electrolyte away from eyes or skin.		Disconnect the equipment before carrying out maintenance or repair
	Do not connect the Pack's positive(+) and negative(-) terminal reversely.		Earth terminal: The inverter must be reliably grounded.
	Observe precautions for handling electrostatic discharge sensitive devices.		Instruction manual: Read the instruction manual before starting installation and operation.
	Caution, risk of electric shock, energy storage timed discharge.		CE mark: The inverter complies with the CE directive.
	Recyclable.	NOTE	Note: The procedures taken for ensuring proper operation.
	Do not use the Pack beyond specified conditions.		

 Take care! This Pack is heavy enough to cause serious injury.

 EU WEEE mark: Product should not be disposed as household waste.

Product Overview

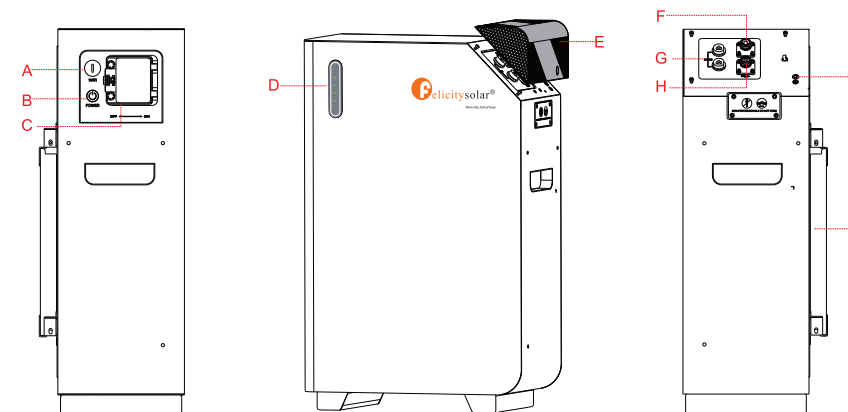

Code	Name
A	WIFI
B	Power On/Charging Indicator
C	ON/OFF Switch
D	LED
E	Decorative Cover
F	POS+
G	COM
H	NEG-
I	PE
J	Wall mounting Bracket (Optional)

* Fuse(Non professionals are not allowed to open this cover)



If the fuse is burnt out, please open the cover and replace it

Installation Environment

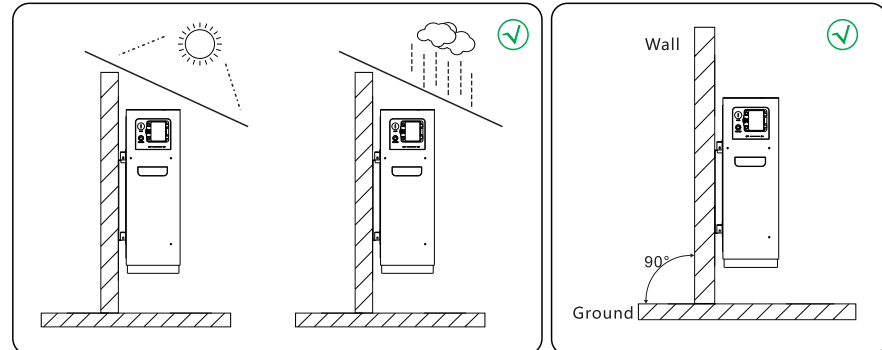

LCD Display Icons

The LED shows the SOC of module N.

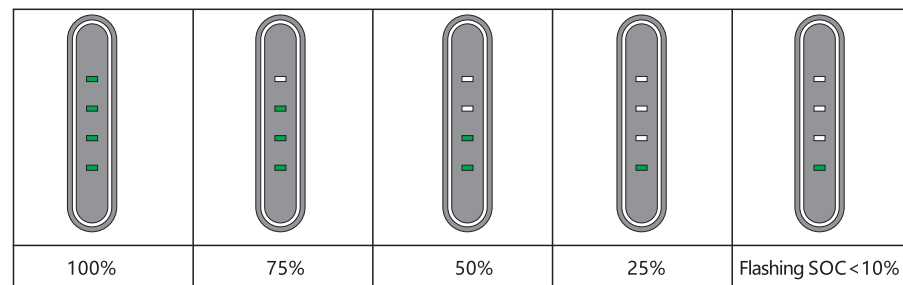

Note: The battery need to be fully charged for at least once in one month to ensure the accurate SOC calculation.

Wall Mounting Procedure

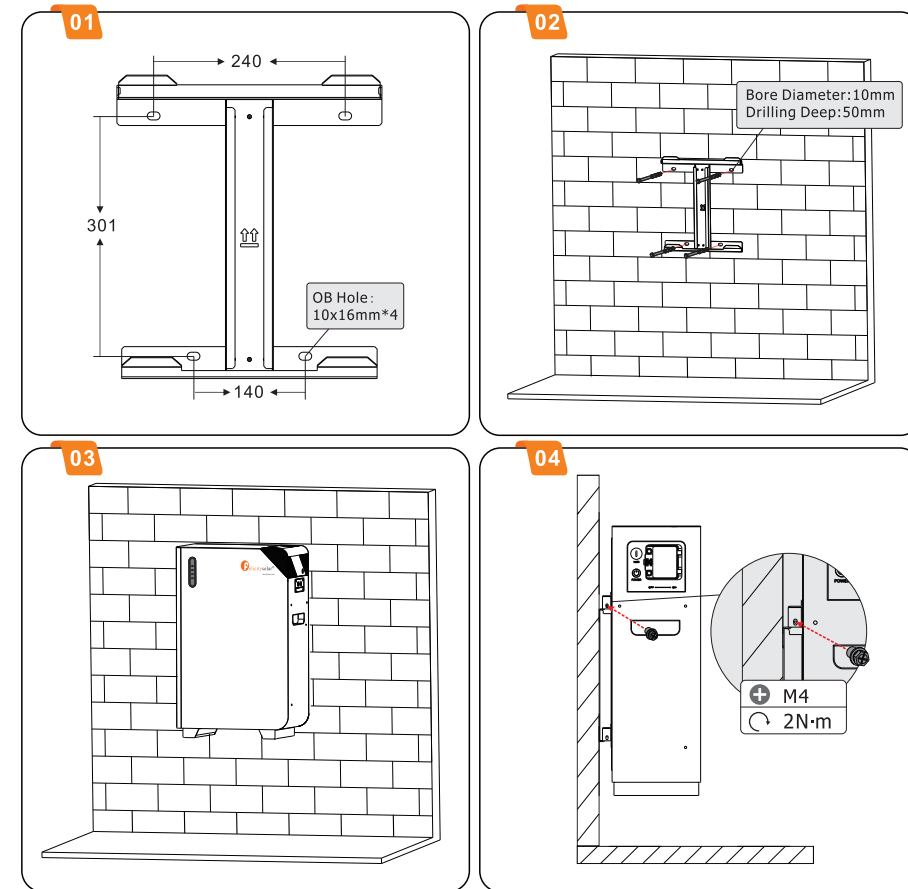

Single Unit Floor-mounted Installation Procedure

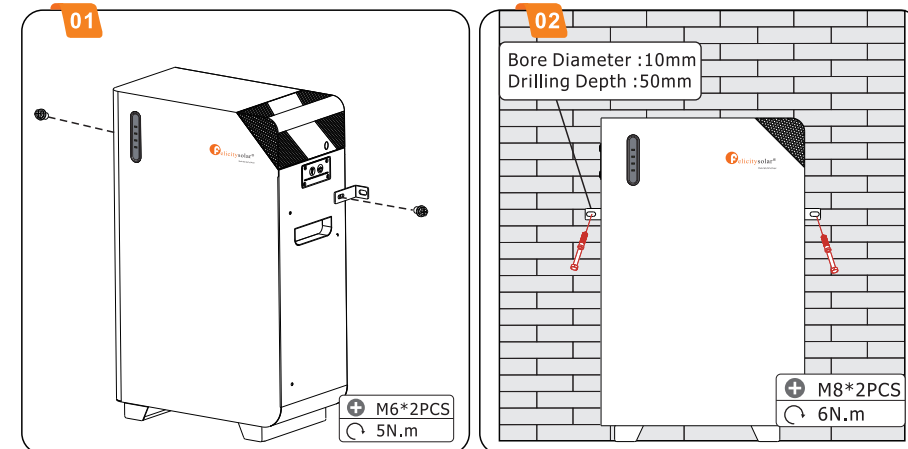

Multiple Units Floor-mounted Installation Procedure

Taking two products as an example, first secure the first unit to the wall (refer to the Single Unit Floor-mounted Installation Method for the procedure), then fasten the stacking brackets to the two units using screws.

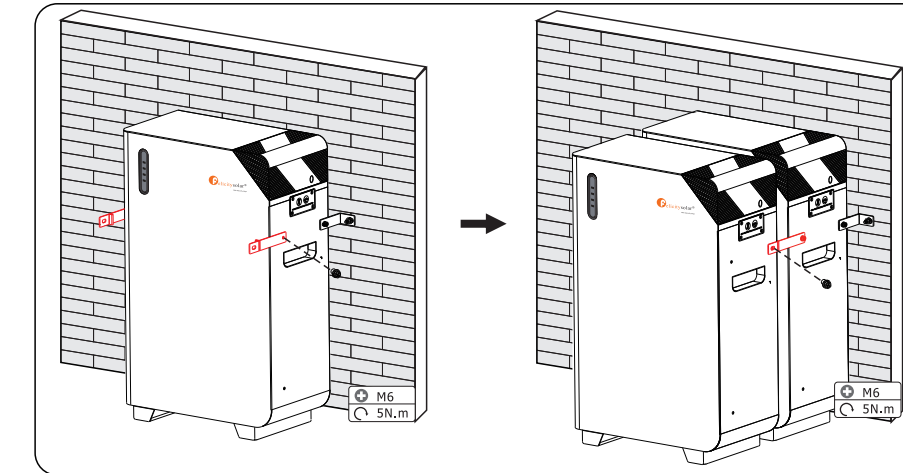

Wiring Procedure

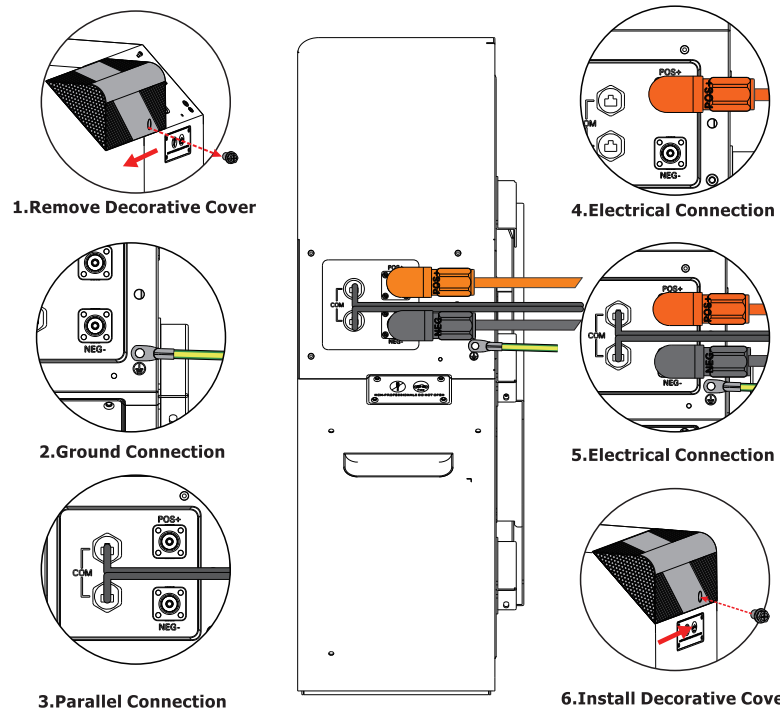

Connection For Parallel Mode

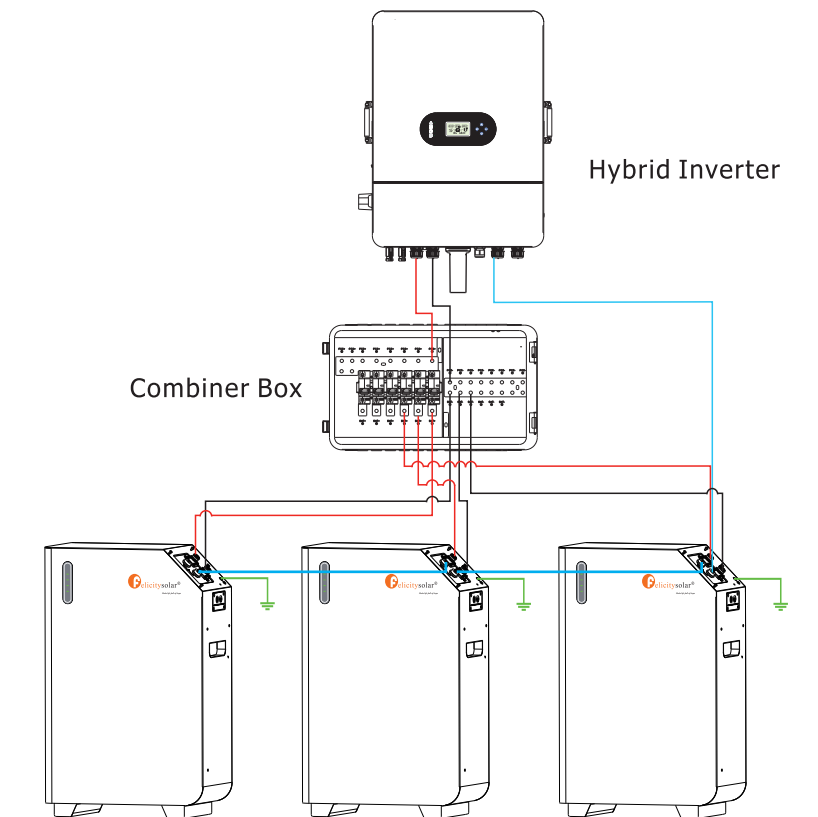

Installation Of Wifi Module

For detailed instructions on how to install WIFI Module, you can scan the QR code to the right to view the WiFi Module installation instructions.



WiFi Module